

2.495V Programmable Shunt Voltage Reference

DESCRIPTION

TS431 integrated circuits are three-terminal programmable shunt regulator diodes. These monolithic IC voltage references operate as a low temperature coefficient zener which is programmable from V_{REF} to 36V with two external resistors. These devices exhibit a wide operating current range to 250mA with a typical dynamic impedance of 0.2Ω . The characteristics of these references make them excellent replacements for zener diodes in many applications such as digital voltmeters, power supplies, and op amp circuitry. The 2.495V reference makes it convenient to obtain a stable reference from 5.0V logic supplies, and since The TS431 operates as a shunt regulator, it can be used as either a positive or negative stage reference.

FEATURES

- Programmable Output Voltage up to 36V
 - TS431A – V_{REF} 2.495V $\pm 1\%$ tolerance
 - TS431B – V_{REF} 2.495V $\pm 0.5\%$ tolerance
- Fast Turn-On Response
- Sink Current Capability: 120mA
- Low Dynamic Output Impedance: 0.2Ω (Typ.)
- Min. Operating Cathode Current: 0.2mA (Typ.)
- Compliant to RoHS Directive 2011/65/EU and in accordance to WEEE 2002/96/EC
- Halogen-free according to IEC 61249-2-21

APPLICATION

- SMPS
- Lighting
- Telecommunication
- Home appliance



SOT-23

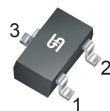

Pin Definition:

1. Cathode
2. Reference
3. Anode

Notes: MSL 3 (Moisture Sensitivity Level) per J-STD-020

SIMPLIFIED SCHEMATIC

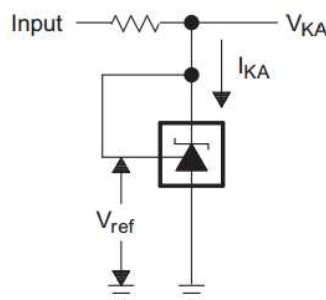

ABSOLUTE MAXIMUM RATINGS ($T_A = 25^\circ\text{C}$ unless otherwise noted)			
PARAMETER	SYMBOL	LIMIT	UNIT
Cathode Voltage	V_{KA}	36	V
Continuous Cathode Current	I_K	120	mA
Reference Input Current	I_{REF}	10	mA
Power Dissipation	P_D	0.25	W
Operating Temperature Range	T_{OPER}	-40 ~ +125	$^\circ\text{C}$
Junction Temperature	T_J	+150	$^\circ\text{C}$
Storage Temperature Range	T_{STG}	-40 ~ +150	$^\circ\text{C}$

THERMAL PERFORMANCE			
PARAMETER	SYMBOL	LIMIT	UNIT
Thermal Resistance - Junction to Case	$R_{\theta JC}$	110	$^\circ\text{C/W}$
Thermal Resistance - Junction to Ambient	$R_{\theta JA}$	350	$^\circ\text{C/W}$

Note: Consider measured with the PCB copper area of approximately 1 in² (Multi-Layer)

ELECTRICAL SPECIFICATIONS ($T_A = +25^\circ\text{C}$, unless otherwise specified)							
PARAMETER	SYMBOL	CONDITIONS	MIN	TYP	MAX	UNIT	
Reference voltage	V_{REF}	$V_{KA} = V_{REF}, I_K = 10\text{mA}$ (Figure 1)	TS431A	2.470	2.495	2.520	V
			TS431B	2.483		2.507	
Deviation of reference input voltage	ΔV_{REF}	$V_{KA} = V_{REF}, I_K = 10\text{mA}$ (Figure 1) $T_A = -20 \sim 85^\circ\text{C}$	--	25	35	mV	
Ratio of change in Vref to change in cathode Voltage	$\frac{\Delta V_{REF}}{\Delta V_{KA}}$	$I_{KA} = 10\text{mA}$, (Figure 2)	$V_{KA} = 10\text{V to } V_{REF}$	--	-1.2	-2.0	mV/V
			$V_{KA} = 36\text{V to } 10\text{V}$	--	-1.0	-2.0	
Reference Input current	I_{REF}	$R1 = 10\text{k}\Omega, R2 = \infty$ $I_{KA} = 10\text{mA}$ (Figure 2)	--	1.5	3.5	μA	
Deviation of reference input current, over temp.	ΔI_{REF}	$R1 = 10\text{k}\Omega, R2 = \infty, I_{KA} = 10\text{mA}$ $T_A = -20 \sim 85^\circ\text{C}$ (Figure 2)	--	0.4	1.2	μA	
Off-state Cathode Current	$I_{KA}(\text{off})$	$V_{REF} = 0\text{V}$ (Figure 3), $V_{KA} = 36\text{V}$	--	0.1	1.0	μA	
Dynamic Output Impedance	$ Z_{KA} $	$f < 1\text{kHz}, V_{KA} = V_{REF}$ (Figure 1)	--	0.2	0.5	Ω	
Minimum operating cathode current	$I_{KA}(\text{min})$	$V_{KA} = V_{REF}$ (Figure 1)	--	0.2	0.5	mA	

Note: The deviation parameters ΔV_{REF} and ΔI_{REF} are defined as difference between the maximum value and minimum value obtained over the full operating ambient temperature range that applied.

ORDERING INFORMATION

PART NO.	PACKAGE	PACKING
TS431ARIX-Z RFG	SOT-23	3,000pcs / 7" Reel
TS431BRIX-Z RFG	SOT-23	3,000pcs / 7" Reel

CHARACTERISTICS CURVES

($T_C = 25^\circ\text{C}$ unless otherwise noted)

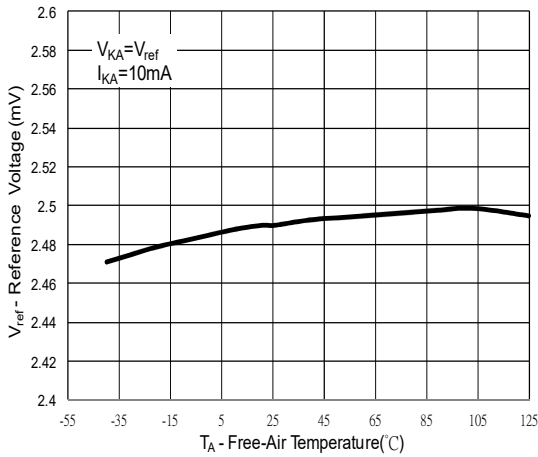

Figure 1. V_{REF} vs. Ambient Temperature

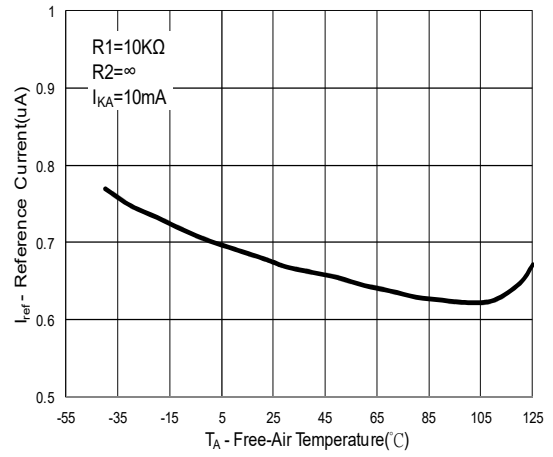

Figure 2. I_{REF} vs. Ambient Temperature

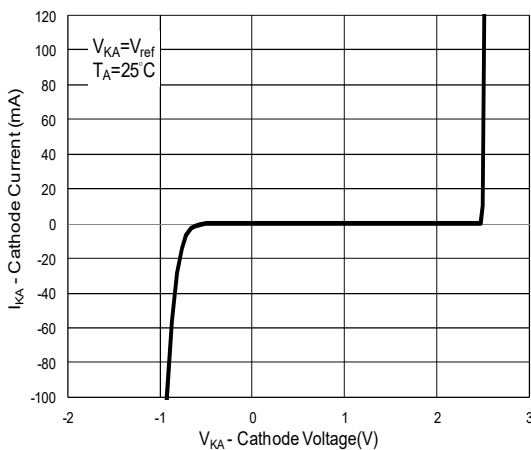

Figure 3. Cathode Current vs. Cathode Voltage

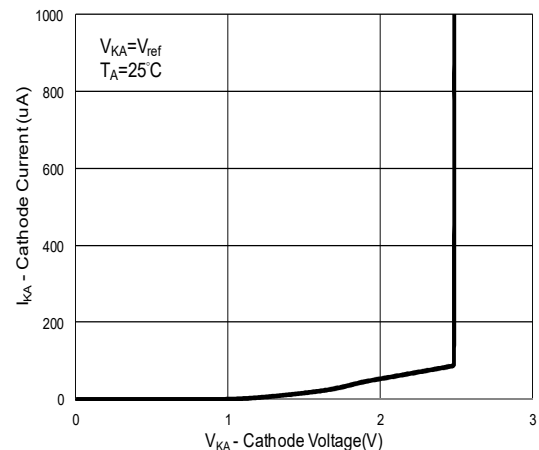

Figure 4. Cathode Current vs. Cathode Voltage

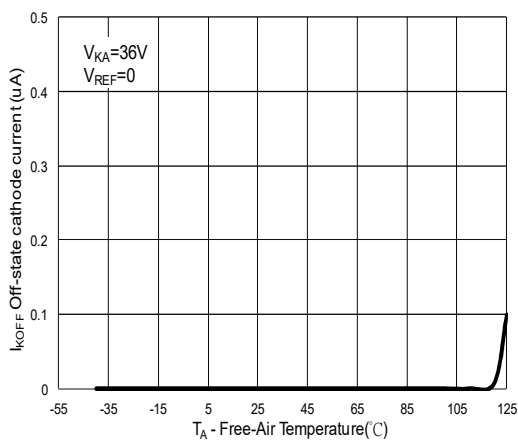

Figure 5. Off-State Cathode current vs. Ambient Temperature

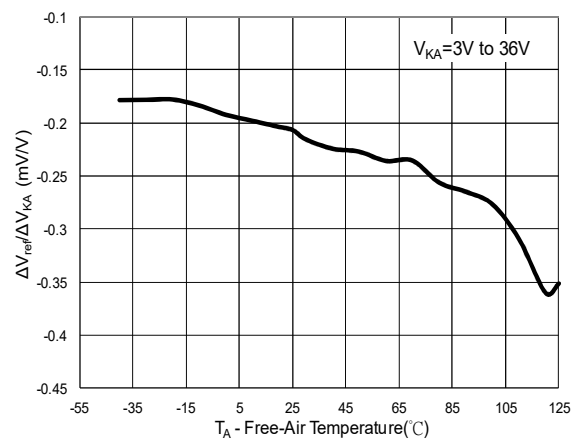
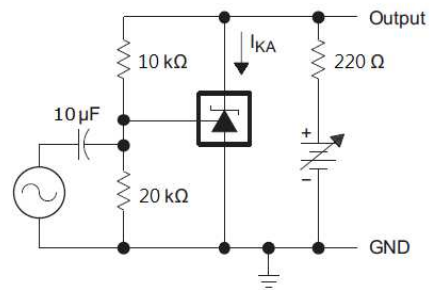
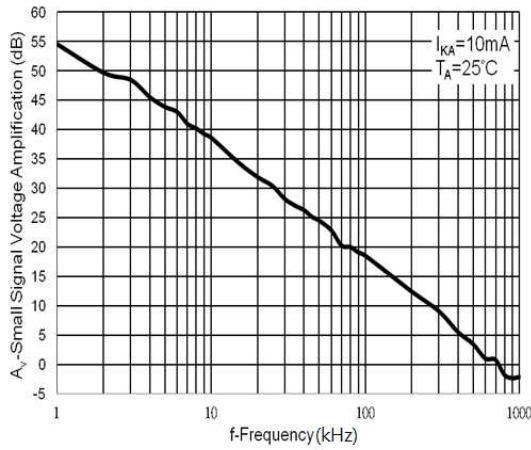

Figure 6. Ratio of delta reference voltage to delta cathode voltage vs. Ambient Temperature

TYPICAL PERFORMANCE CHARACTERISTICS

Small-Signal Voltage Gain and Phase Shift vs. Frequency



Test Circuit For Voltage Amplification

Reference Impedance vs. Frequency

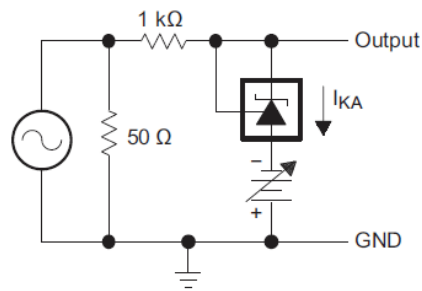
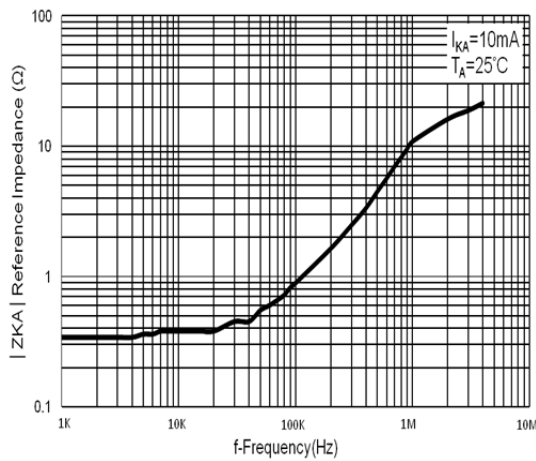

Test Circuit For Reference Impedance

Pulse Response

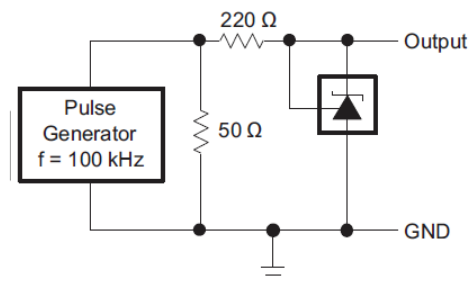
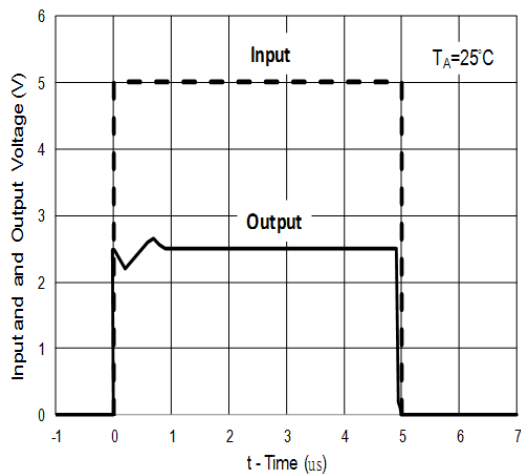

Test Circuit For Pulse Response

TYPICAL PERFORMANCE CHARACTERISTICS

Stability Boundary Condition

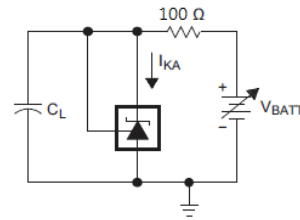
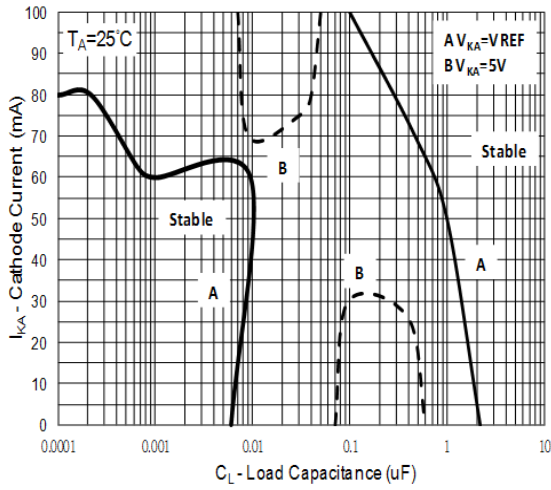

TEST CIRCUIT FOR CURVE A

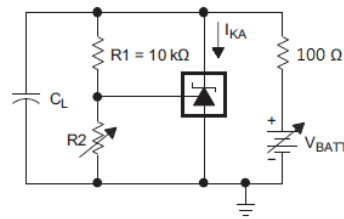

TEST CIRCUIT FOR CURVE B

PACKAGE OUTLINE DIMENSIONS (Unit: Millimeters)

SOT-23

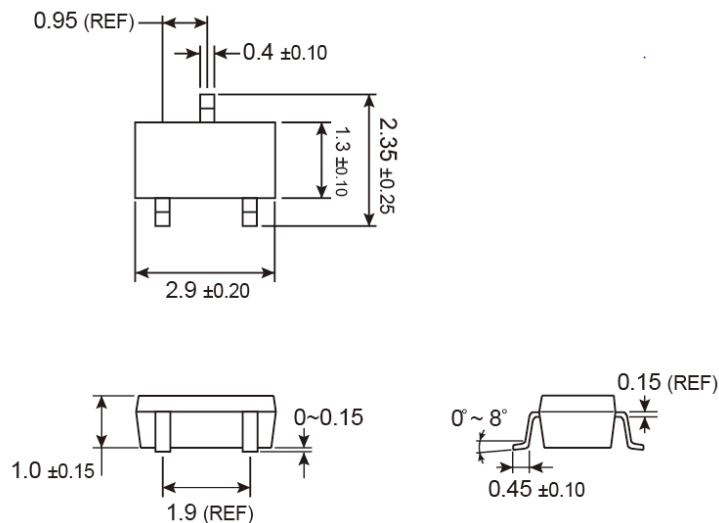

SUGGESTED PAD LAYOUT (Unit: Millimeters)

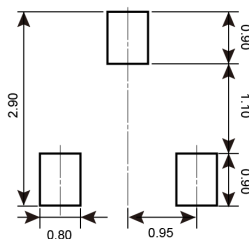

MARKING DIAGRAM

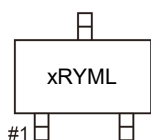

- xR** = Device code
 - A** = TS431A
 - B** = TS431B
- Y** = Year Code
- M** = Month Code for Halogen Free Product
 - O** =Jan **P** =Feb **Q** =Mar **R** =Apr
 - S** =May **T** =Jun **U** =Jul **V** =Aug
 - W** =Sep **X** =Oct **Y** =Nov **Z** =Dec
- L** = Lot Code (1~9, A~Z)

Notice

Specifications of the products displayed herein are subject to change without notice. TSC or anyone on its behalf, assumes no responsibility or liability for any errors or inaccuracies.

Information contained herein is intended to provide a product description only. No license, express or implied, to any intellectual property rights is granted by this document. Except as provided in TSC's terms and conditions of sale for such products, TSC assumes no liability whatsoever, and disclaims any express or implied warranty, relating to sale and/or use of TSC products including liability or warranties relating to fitness for a particular purpose, merchantability, or infringement of any patent, copyright, or other intellectual property right.

The products shown herein are not designed for use in medical, life-saving, or life-sustaining applications. Customers using or selling these products for use in such applications do so at their own risk and agree to fully indemnify TSC for any damages resulting from such improper use or sale.